

speed grip

UN BLOCCAGGIO ECCELLENTE SOTTO OGNI PUNTO DI VISTA
AN EXCELLENT CLAMPING SYSTEM IN EVERY RESPECTS



UTENSILE
 STANDARD
 INFILAMENTO
 FRONTALE

STANDARD
 TOOL
 VERTICAL
 LOADING



INSERIMENTO
 FRONTALE
 VERTICAL
 LOADING



SOLLEVAMENTO
 E RICHIAMO
 AUTOMATICO
 IN BATTUTA
 AUTOMATIC
 LIFTING
 AND HOUSING



FACILE
 ESTRAZIONE
 FRONTALE
 EASY VERTICAL
 CHANGE



INIMITABILE
 AUTO COMPENSANTE
 INIMITABLE
 ELASTIC LIFTING SYSTEM

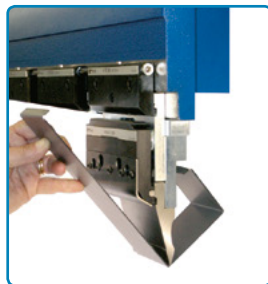

LIBERTA' POSTERIORE
 REAR FREE SPACE

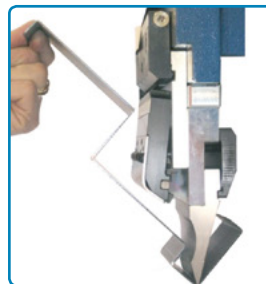

LIBERTA' ANTERIORE
 FRONTAL FREE SPACE

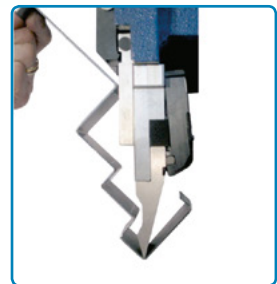

BLOCCAGGIO AUTOMATICO
 POSTERIORE
 REAR AUTOMATIC
 CLAMPING

13131 Flex

INSERIMENTO / ESTRAZIONE FRONTALE UTENSILE CON ATTACCO STANDARD VERTICAL LOADING OF TOOL WITH STANDARD JUNCTION TANG

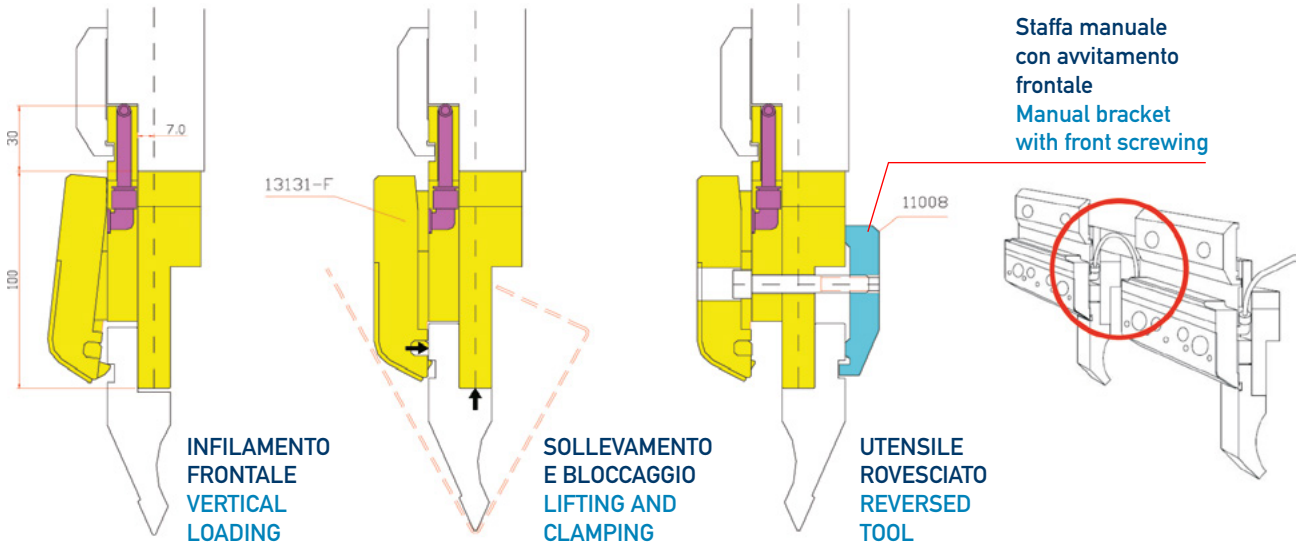

Tubo flessibile alloggiato in posizione protetta che permette un ampio movimento laterale dei moduli e la loro semplice rimozione (con tubo allungato)
Flexible pipe located in secure area allowing wide lateral shifting of the units and their easy removal (with extended pipe)

13131

POSIZIONAMENTO E CENTRATURA AUTOMATICA DEI PUNZONI DURANTE IL BLOCCAGGIO UPPER TOOL AUTOMATIC POSITIONING AND CENTERING DURING CLAMPING

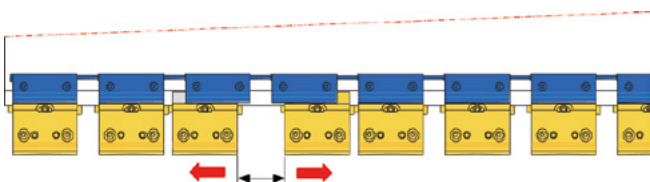
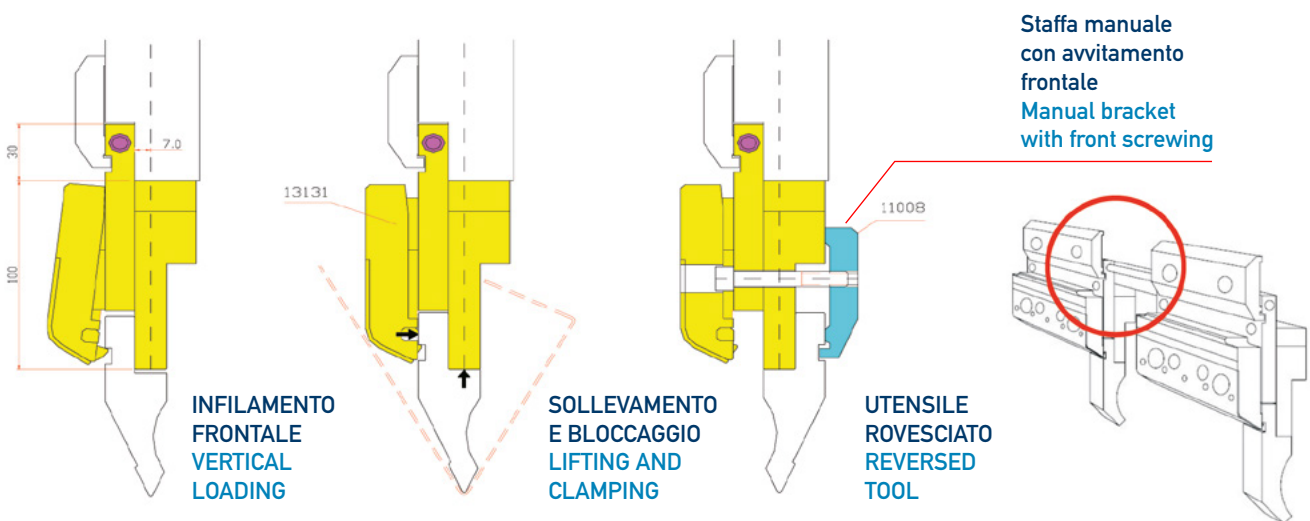

Tubo telescopico che permette un ampio movimento laterale dei moduli
Telescopic manifold allowing wide lateral shifting of the units

13131 Star

SISTEMI PNEUMATICI BREVETTATI – MATERIALI E LAVORAZIONI 100% MADE IN ITALY
 PATENTED PNEUMATIC SYSTEMS – MATERIALS & PRODUCTION 100% MADE IN ITALY

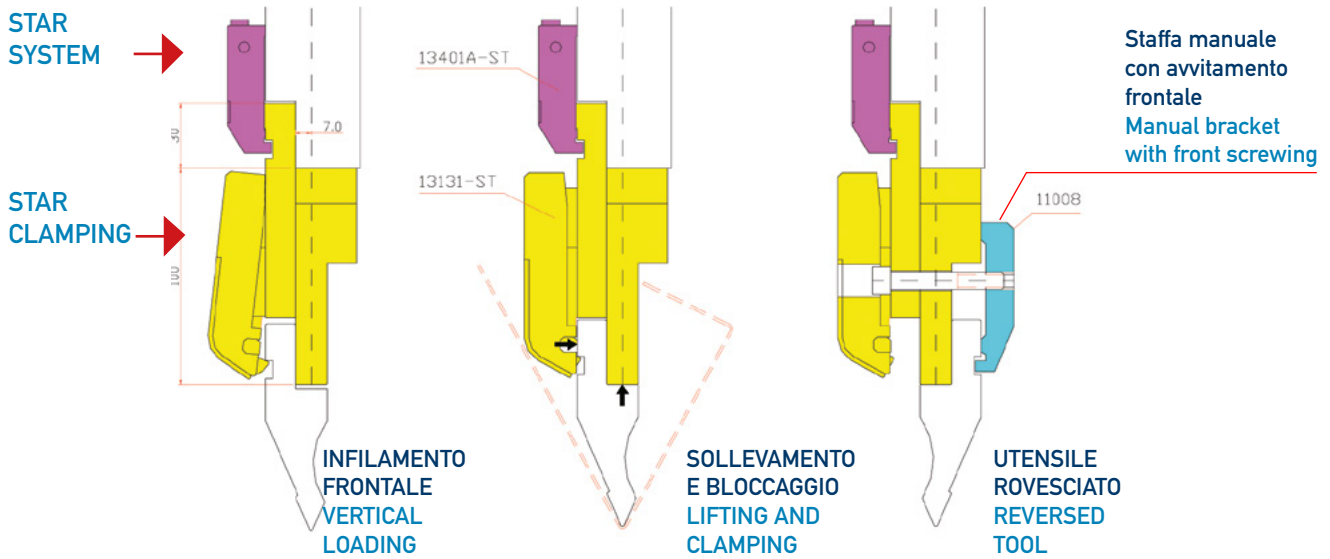

Innovativo sistema "star" che permette la rimozione di uno o più moduli con un semplice gesto, in assoluta libertà
 The innovative "star" system allows the removal of one or more units with an easy action.

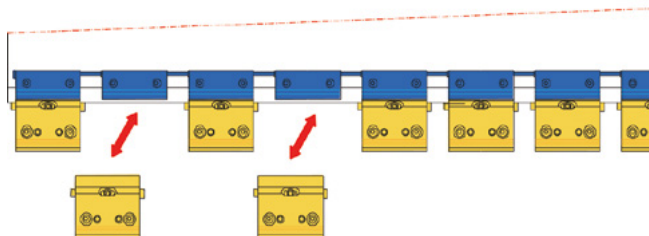

NESSUN TUBO
DI COLLEGAMENTO
COMPLETA LIBERTÀ

NO CONNECTION PIPES
TOTAL FREEDOM

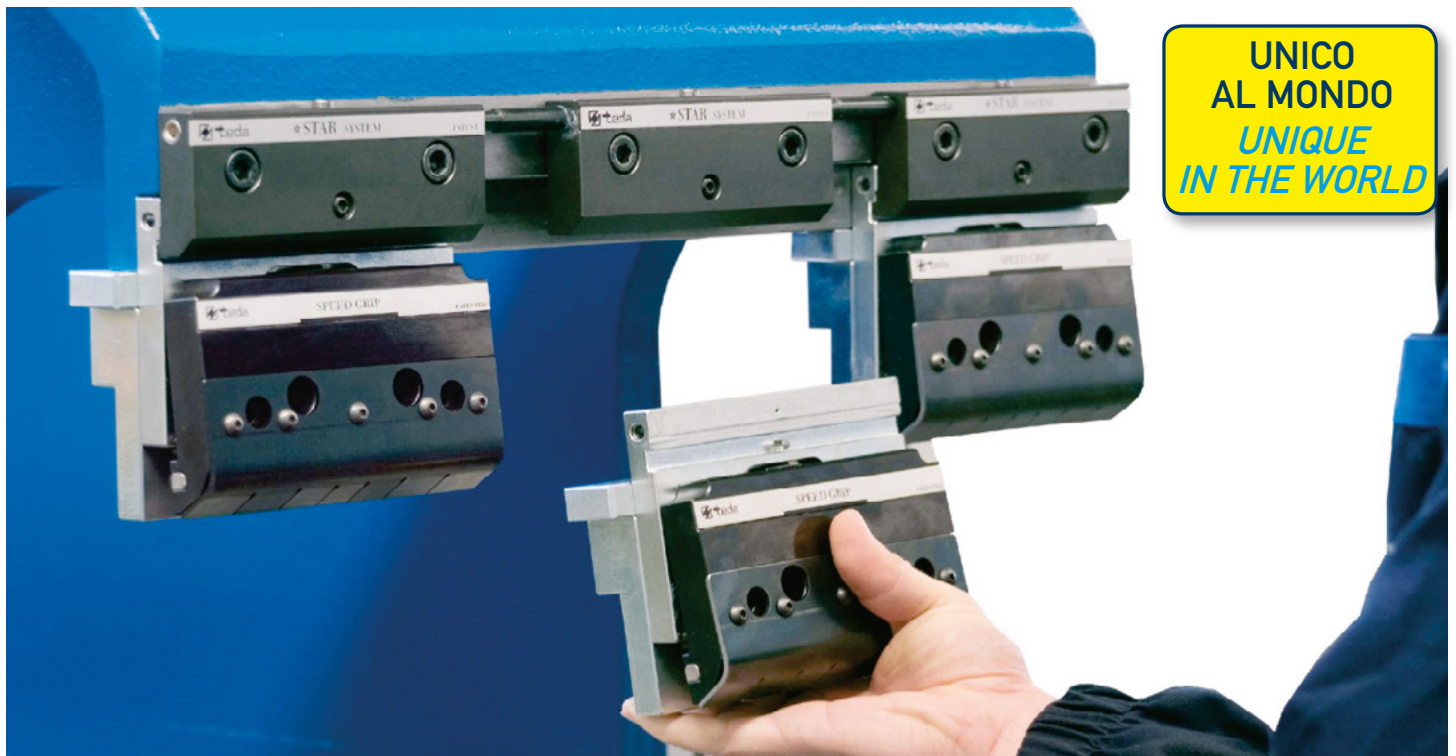

**UNICO
AL MONDO
UNIQUE
IN THE WORLD**

MATRICI DIES

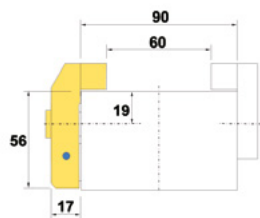

mod. 21202-W

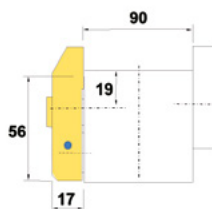

mod. 21203-W

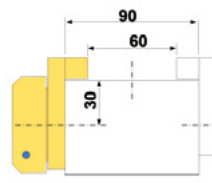

mod. 21101

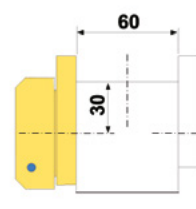

mod. 21001

ADATTABILI A QUALUNQUE TAVOLA • SVARIATI MODELLI DISPONIBILI - SUITABLE FOR ANY TABLE • AVAILABLE IN SEVERAL MODELS

MODULI DI BLOCCAGGIO PNEUMATICO MATRICI CON CILINDRI AD ASOLA RICAVATI DIRETTAMENTE NEL CORPO DEI SUPPORTI

- staffa elastica
- garanzia di bloccaggio certo di matrici frazionate
- ampia sezione di spinta su tutta la staffa
- elevata forza di bloccaggio

PNEUMATIC CLAMPING UNITS FOR DIES WITH SLOT CYLINDERS IN THE DIES BRACE

- elastic bracket
- clamping of sectioned dies assured
- wide thrust on the entire bracket
- high clamping force

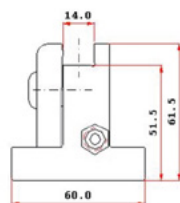

21005

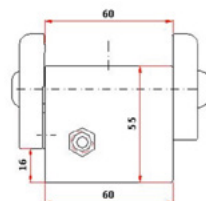

21006



Innesto rapido
tra i moduli
Quick coupling
between units

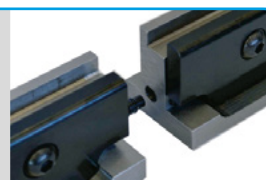

RISPARMIO DI TEMPO dell'80% rispetto ad un bloccaggio manuale tradizionale con viti
80% TIMESAVING compared to a traditional manual clamping with screws

BLOCCAGGIO MANUALE TRADIZIONALE (CON VITI) TRADITIONAL MANUAL CLAMPING (WITH SCREWS) cambio utensili = 1 ciclo - upper tool change = 1 cycle piegatrice da 3mt / 15 unità di bloccaggio - 3-mt long press brake / 15 clamping units	tempo in secondi time in seconds
allentamento 30 viti (5 sec. cad.) - 30 screw loosening (5 sec. each)	150
estrazione laterale utensile 4x835 - horizontal tool change 4x835	100
inserimento laterale nuovi utensili - new tool horizontal loading	100
pre-avvitamento 30 viti (4 sec. cad.) - 30 pre-screwing (4 sec. each)	120
leggera pressata per appoggio utensili - light pressing to house tool	10
avvitamento definitivo 30 viti (3 sec. cad.) - 30 final screwing (3 sec. each)	90
tempo medio necessario: 9 min 30 sec. - average necessary time: 9 min 30 sec	570

BLOCCAGGIO PNEUMATICO SPEED GRIP 13000-F / 13000 / 13000-ST PNEUMATIC CLAMPING SYSTEM SPEED GRIP 13000-F / 13000 / 13000-ST cambio utensili = 1 ciclo - upper tool change = 1 cycle piegatrice da 3mt / 15 unità di bloccaggio - 3-mt long press brake / 15 clamping units	tempo in secondi time in seconds
attivazione sbloccaggio - clamping units unlocking	5
estrazione frontale utensili - tool vertical change 4x835	32
inserimento frontale nuovi utensili - new tool vertical loading	24
attivazione bloccaggio - clamping units locking	5
tempo medio necessario: 1 min 06 sec. - average necessary time: 1 min 06 sec	66

